

Made for Motion



EVOLASTIC®

Highly flexible couplings

ktr.com

Fast, easy and reliable - with the product finder and our online tools

The product finder allows you to get to the suitable product in just a few steps. For this purpose either make use of the search function if you already know the product or use the full-text search which guides you to the requested result via various product-specific filters. Our selection tools speed up the detailed product selection. Few tech-

nical data suffice to rapidly find the right product for your application in the configurators - without having to browse catalogues lengthily.



Online tools

Tailor-made to your specifications - make use of our online tools



Product finder

The suitable product for your application - fast and simple with our product finder.

EVOLASTIC®

Highly flexible couplings

Examples of application



Pumps



Shredders



Tractors



Cooling towers



Stage technology



Snow groomers



Yachts



Piston compressors

EVOLASTIC®

Highly flexible couplings

Properties of flexible jaw and pin & bush couplings

					
Product	ROTEX®	EVOLASTIC®	POLY-NORM®	POLY	REVOLEX®
Type	Torsionally flexible jaw coupling	Highly flexible jaw coupling	Torsionally flexible jaw coupling	Torsionally flexible jaw coupling	Torsionally flexible pin & bush coupling
Features					
Torsionally flexible	●	●	●	●	●
Highly flexible		●			
Damping vibrations	●	●	●	●	●
Maintenance-free	●	●	●	●	●
Axial plug-in	●	●	●	●	●
Shear type				●	
Fail-safe	●	●	●		●
Compensating for misalignment	●	●	●	●	●
Types					
Variant diversity	very high	very high	average	average	high
Special features	extensive basic programme available from stock while customised solutions can be realized	reducing torsional vibrations and compensating for misalignment above average with compact dimensions, extremely flexible for individual drives	basic programme available from stock	basic programme available from stock	extensive programme, ideal for customised solutions, for applications with high performance ranges
Applications / core industries	manifold applications, applicable in all industries	flexible all-rounder coupling for wide applications in mechanical and plant engineering	pump industry, industrial gearboxes	chemical pumps, high-pressure pumps, ...	industrial gearboxes, conveyor systems, industrial fans, cableways, agitators, generators, ...
surface	allover machining, very good dynamic properties	machined, optionally available with corrosion protection, soft elastomer	shell surface machined	shell surface machined	allover machining, good dynamic properties
Torque range T_{KN} [Nm]					
Min.	7.5	100	40	42	4,300
Max.	35,000	5,600	67,000	6,100	1,350,000
Max. circumferential speed v [m/s]					
Cast EN-GJL (dynamic balancing)	35		35	35	35
Steel + cast EN-GJS (dynamic balancing)	60	60			60
Hub materials available					
Steel (semi-finished product) » customised solutions available	●	●			●
Cast iron (GJL) » subject to mould	●		●	●	●
Nodular iron (GJS) » subject to mould	●		○		○
Aluminium wrought products (Al-H) » customised solutions available	●				
Aluminium diecast (Al-D)	●				
Stainless steel	●	On request			
Corrosion-protected types	●	○	○	○	●
Spiders / elastomers					
Material	T-PUR®, PA, PEEK, Hytrel, ...	NR + EPDM	NBR (up to size 180) T-PUR® (from size 200)	NBR	NR, NBR NBR electrically insulating
Degree of hardness	flexible to torsionally rigid	highly flexible compounds W, S, M	flexible	flexible	flexible
Temperature range in °C, min. / max. (standard)	-50 / +120	-40 / +80	-30 / +80	-30 / +80	-30 / +80
Temperature range in °C, min. / max. (special)	-50 / +250	-30 / +100	-30 / +80	-30 / +80	-50 / +80

● ≈ Standard
○ ≈ On request

EVOLASTIC®

Highly flexible couplings

Properties of flexible jaw and pin & bush couplings

					
Product	ROTEX®	EVOLASTIC®	POLY-NORM®	POLY	REVOLUX®
Type	Torsionally flexible jaw coupling	Highly flexible jaw coupling	Torsionally flexible jaw coupling	Torsionally flexible jaw coupling	Torsionally flexible pin & bush coupling
Geometries					
Design	compact	short	short	short	short
Mass moment of inertia	low	low	average	high	average
Shaft distance dimension	low / average	low	low	low	low
Types (extract)					
Elastomers can be radially disassembled » with no need of displacing driving/driven side	AFN, AH, SH, ZR, DF, DFN, CF-H	D2H, DFH	ADR, ADR-SB	PKD	Standard
Intermediate shaft types » bridging larger shaft distances	ZR, ZWN	D2H, DFH	–	–	customised
Standard spacers 100 mm to 250 mm	ZS-DKM-H	–	AZR	PKA	customised
Shaft-to-shaft connection	Standard	EH, E2H, EHP, E2HP	Standard	Standard	Standard
Flange-to-shaft connection	CF, CFN	EFH, EFHP	–	–	customised
Flange-to-flange connection » particularly short mounting length	DF, DNF	customised	–	–	customised
Double-cardanic » compensating for big displacements, lower restoring forces	ZS-DKM-H, ZR, ZWN	D2H, DFH	–	–	–
Certifications / type examinations					
ATEX 	●	○	●	●	●
UL-listed 	●	○			
GOST R / GOST TR 	●	○	●	●	●
DNV/GL 	●	○			●
ABS 	●	○			○
Bureau Veritas 	●	○			○
LR 	○	○			○
RS CLASS 	○	○			○
CCS 	○	○			○
ClassNK 	○	○			

● ≈ Standard
○ ≈ On request

EVOLASTIC®

Highly flexible couplings

Description of product and application

The EVOLASTIC® is a highly flexible, non-slip and backlash-free shaft and flange coupling for flexible use in a large number of main and auxiliary drives in mechanical and plant engineering.

Subject to the elastomer element pre-stressed to pressure, the coupling is able to reduce torsional vibrations in the drive train and absorb overload shocks smoothly. Structure-borne noise is damped efficiently. At the same time it offsets misalignment above average in three dimensions (axially, radially and angularly).

The key component of this series is a vulcanised, circularly closed elastomer element made of natural rubber (WN, SN, MN, up to 80 °C) or for higher temperatures made of synthetical EPDM material (WE, SE, ME, up to 100 °C). The various kinds of rubber hardness cover one application and torque range per size.

The basic variants distinguish between directly screwed types and pluggable types. They cover all practical mounting conditions ranging from a finished individual component through hub/hub and flange/hub applications to the driving shaft. Apart from that the product portfolio allows for highly individual and flexible mounting options, tailor-made for the special application.



Technical data													
Size	Elastomer type ²⁾	Torque [Nm] ¹⁾				Dynamic torsion spring stiffness C _{dyn.} [Nm/rad]		Relative damping ψ [-]		Perm. damping power P _{KW} [W]		Operating speed [rpm]	
		T _{KN}	T _{Kmax}	T _{Kmax1}	T _{KW}	30 °C	60 °C	30 °C	60 °C	30 °C	60 °C	n	n _{max.}
		12	SN	100	200	300	40	900	720	0.80	0.64	25	15
	MN	120	240	360	48	1,500	1,200	1.10	0.88			5,400	6,000
	SN	200	400	600	80	2,000	1,600	0.80	0.64			3,780	4,200
24	MN	240	480	720	96	3,600	2,880	1.10	0.88	40	24	4,500	5,000
	SN	420	840	1,260	168	6,800	5,440	0.80	0.64			3,780	4,200
48	MN	480	960	1,440	192	13,500	10,800	1.10	0.88	75	45	4,500	5,000
	SN	500	1,000	1,500	200	4,600	3,680	0.80	0.64			3,240	3,600
60	MN	600	1,200	1,800	240	7,750	6,200	1.10	0.88	80	48	3,600	4,000
	SN	760	1,520	2,280	304	12,500	10,000	0.90	0.72			3,600	4,000
86	MN	860	1,720	2,580	344	21,000	16,800	1.10	0.88	90	54	4,050	4,500
	SN	1,100	2,200	3,300	440	8,800	7,040	0.80	0.64			2,880	3,200
125	MN	1,250	2,500	3,750	500	16,000	13,600	1.10	0.88	120	72	3,240	3,600
	SN	1,700	3,400	5,100	680	29,000	23,200	0.90	0.72			3,060	3,400
200	MN	2,000	4,000	6,000	800	44,000	35,200	1.10	0.88	150	90	3,240	3,600
	WN	2,400	4,800	7,200	960	38,000	30,400	0.70	0.56			2,700	3,000
280	MN	2,800	5,600	8,400	1,120	78,000	62,400	1.10	0.88	170	102	3,060	3,400
	WN	3,200	6,400	9,600	1,280	48,500	38,800	0.70	0.56			2,700	3,000
360	SN	3,400	6,800	10,200	1,360	67,000	53,600	0.90	0.72	200	120	3,060	3,400
	MN	3,600	7,200	10,800	1,440	115,000	92,000	1.10	0.88			3,060	3,400
	WN	5,000	10,000	15,000	2,000	73,500	58,800	0.80	0.64			2,250	2,500
560	SN	5,200	10,400	15,600	2,080	105,000	84,000	1.00	0.80	240	144	2,520	2,800
	MN	5,600	11,200	16,800	2,240	138,000	110,400	1.10	0.88			2,700	3,000

¹⁾ T_{KN} Torque that can be constantly transmitted over the entire speed range.
T_{Kmax} Transient torque peaks (e. g. resonance passage), max. 100,000 load alternation pulsating / 50,000 load alternation vibratory
T_{Kmax1} Torque loads rarely, max. 1,000 load alternation
For selection consider DIN 740 part II (operating factor, temperature factor), parameters for an ambient temperature of 30 °C.
²⁾ Higher strength on request.

Types

Types screwed axially	
E	Elastomer + set of screws
EH	Elastomer + hub (drive)
E2H	Elastomer + two hubs (driving and driven side)
EFH	Elastomer + flange (drive) + hub (driven side)
D2H	Two elastomers + intermediate shaft + two hubs
DFH	Two elastomers + intermediate shaft + flange and hub



Types plugged in axially	
EP	Elastomer + locking pin
EHP	Elastomer + hub (drive), pluggable
E2HP	Elastomer + two hubs (driving and driven side), pluggable
EFHP	Elastomer + flange (drive) + hub (driven side) pluggable



EVOLASTIC®

Highly flexible couplings

Types of hubs

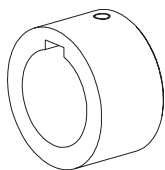

Type 1.0
with feather keyway
and setscrew

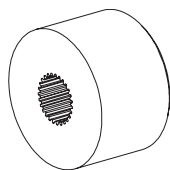

Type 1.3
Profile gearing

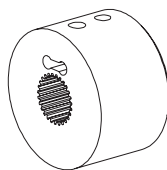

Type 3.1
Clamping hub N with
spline bore

Other hub connections on request.

Examples:

- Slotted clamping hub
- Clamping ring hub
- taper or cylindrical press fit
- split hub

Displacements / Displacement stiffness

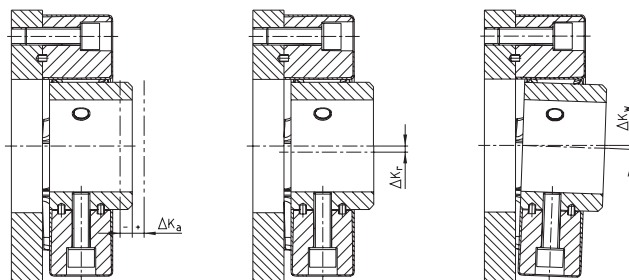

EVOLASTIC® size	12	24	48	60	86	125	200	280	360	560
Perm. axial displacement ΔK_a [mm]	±2.5	±3.0	±2.5	±3.0	±3.0	±3.5	±3.0	±3.5	±4.0	±4.0
Perm. radial displacement ΔK_r [mm]	1,500 rpm	2	2	2	2.5	2	2.5	2.5	3	3
	Max. ¹⁾	2.5	2.5	3.5	3.5	3.5	3.5	3.5	5.0	5.0
Perm. angular displacement ΔK_w [°]	1,500 rpm	3.0	3.0	2.0	3.0	2.0	3.0	2.0	2.0	2.0
	Max. ^{1) 2)}	6.0	6.0	4.0	6.0	4.0	6.0	4.0	4.0	4.0

¹⁾ With assembly for a short time resp. rarely with downtime or start-up operation as well as exceptional load conditions.

²⁾ Check clearance for angular joint deflection.

The radial and angular displacement of a coupling element refers to an operating speed of 1,500 RPM. Following the graph the permissible operating displacement increases with lower speed or reduces with rising speed by the factor f_{rpm} . The combination of radial and angular displacement in an application is divided up as a percentage. The permissible displacement refers to the total of alignment and operating displacement.

Size	Elastomer hardness	Axial stiffness C_a [N/mm]		Radial stiffness C_r [N/mm]		Angular stiffness C_w [N/°]	
		30 °C	60 °C	30 °C	60 °C	30 °C	60 °C
		12	S	50	40	280	224
	M	70	56	400	320	3.0	2.4
24	S	70	56	400	320	4.0	3.2
	M	100	80	550	440	5.0	4.0
48	S	270	216	1,000	800	10	8.0
	M	420	336	1,500	1,200	15	12
60	S	100	80	440	352	10	8.0
	M	120	96	650	520	14	11
86	S	390	312	1,300	1,040	24	19
	M	490	392	1,625	1,300	30	24
125	S	150	120	650	520	15	12
	M	200	160	920	736	22	18
200	S	420	336	1,700	1,360	45	36
	M	525	420	2,125	1,700	56	45
280	W	460	368	1,150	920	58	46
	M	800	640	2,800	2,240	95	76
360	W	450	360	1,800	1,440	66	53
	S	550	440	2,200	1,760	80	64
	M	710	568	2,500	2,000	100	80
560	W	380	304	1,950	1,560	95	76
	S	480	384	2,500	2,000	120	96
	M	620	496	3,000	2,400	150	120

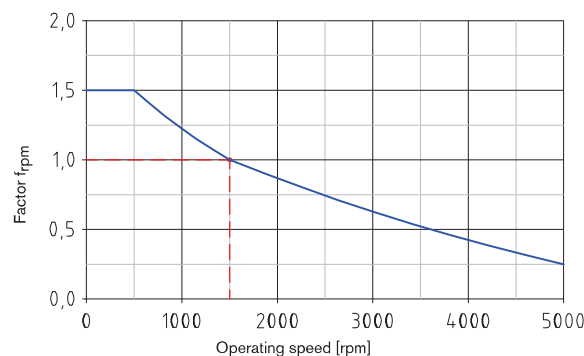
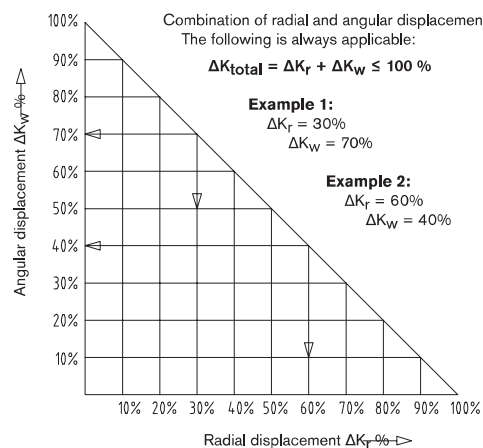

EVOLASTIC® EFH

Highly flexible couplings

Flange-to-shaft connection

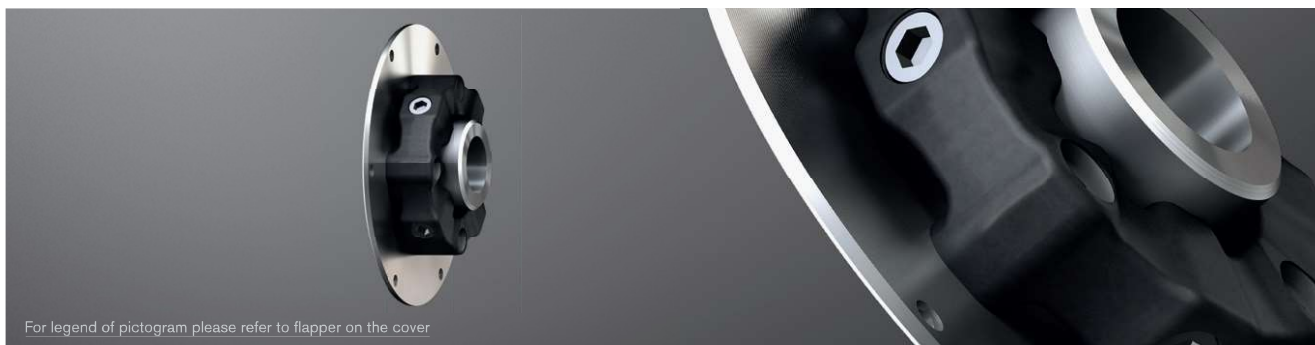

For legend of pictogram please refer to flapper on the cover



Components

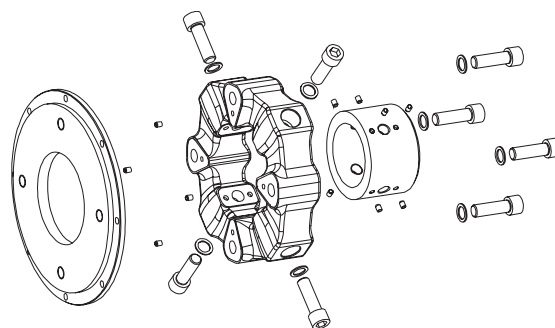
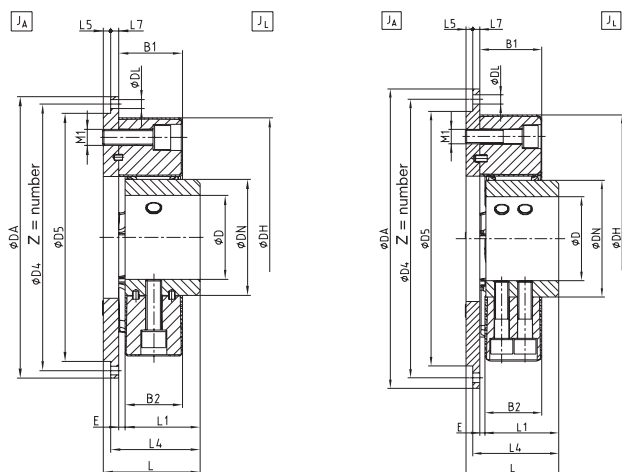

Flange dimensions according to SAE J620 [mm]				
Size	DA	D4	Z	DL
6 1/2"	215.90	200.02	6	9
7 1/2"	241.30	222.25	8	9
8"	263.52	244.47	6	11
10"	314.32	295.27	8	11
11 1/2"	352.42	333.37	8	11
14"	466.72	438.15	8	13

EVOLASTIC® type EFH																						
Size	Flange connection acc. to SAE - J620					Dimensions [mm]											Mass moment of inertia [kgm ²] ¹⁾		Weight [kg] ¹⁾			
	6.5"	7.5"	8"	10"	11.5"	14"	DH	D ¹⁾	DN	B1	B2	E	L	L1	L4	L5	L7	M1		D5	J _A	J _L
12	●						122	38	60	32	28	4	56	42	52	4	6	M10	180	0.013	0.001	3.26
		●																	190	0.020	0.001	3.78
24	●						150	48	70	42	36	6	68	50	62	6	6	M12	180	0.016	0.002	4.20
		●																	190	0.023	0.002	4.77
48		●					170	55	85	46	40	6	75	55	67	8	6	M14	190	0.026	0.005	6.03
			●												71	4	10		200	0.034	0.005	6.62
				●															260	0.091	0.005	9.91
60			●				200	65	100	58	50	8	90	66	84	6	10	M16	270	0.103	0.011	12.07
				●															310	0.165	0.011	14.49
86				●			200	65	100	58	50	8	90	66	84	6	10	M16	270	0.105	0.012	12.52
					●														360	0.166	0.012	14.94
125					●		260	85	125	70	63	8	107	80	98	9	10	M16	270	0.129	0.034	16.72
						●													310	0.199	0.034	19.57
																			270	0.135	0.039	17.64
200						●	260	85	125	70	63	8	107	80	98	9	10	M20	310	0.205	0.039	20.50
																			405	0.572	0.039	30.01
280							300	105	145	80	72	8	121	94	112	9	10	M20	310	0.226	0.072	23.54
																			405	0.593	0.072	33.05
360						●	340	115	160	85	78	8	127	100	118	9	10	M20	405	0.628	0.130	37.55
560						●	363	120	170	105	95	10	160	125	145	15	25	M24	405	0.794	0.203	49.06

¹⁾ With max. bore

Ordering example:	EVOLASTIC® 48	EFH	S	8	1.0	Ø52
	Coupling size	Type	Elastomer hardness	Flange ØDA acc. to SAE or special	Hub type	Finish bore

